



UREFOOT

HARDSCAPE PRODUCTS INC.

2022



WE WILL ROCK YOU!

We would like to thank all our dealers/contractors that believed in us, for trying our products, and working with our company. It is thanks to you that we now have dealers across North America. Yes we have grown, but we have remained true to our grass roots and are still a family run company.

Going back to our first year...we only had 3 products, a plastic paver edge, an aluminum paver edge, and spikes. We now offer a full line of products and shop the world to bring you accessories that we believe in and have tested extensively before offering them to you. Nobody should be a guinea pig in this business! Not you or your customers. Our products are tried, tested and true.

We are Surefoot Hardscape Products!



VIDEO LINK

WE WILL ROCK YOU!

How we began?

It started out as a simple idea.

Over the years, as installers and working with various types of paver edgings, we worked on improving and developing a design for paver edging that has an ELEVATED snip/cut brace that's off the ground. This design proves to save time when installing, eliminating the need to pre-measure and pre-cut allowing the installer to cut from above.

AND THAT'S HOW SUREFOOT



EDGING WAS BORN!



SUREFOOT

HARDSCAPE PRODUCTS INC.

CONTENTS

Surefoot Paver Edging	4
Sureflex Paver Edging	6
Aluminum Paver Edging	8
Aluminum Paver Edging - Low Profile	10
Grateful Edge	11
Rockstar Garden Edge	12
Rockstar Garden Edge - Back in Black	13
Rockstar Garden Edge XS	14
Xtreme Bond	15
Inverted Marking Paint / Geogrid	16
The Wedgie / Wall Drain Pro	17
Hammers	18
Accessories & Tools	20
Lifting Equipment	22 / 23
Splitters	24/25
Lite On	25
Paver Spot	26
Slim Shady / Cyclops	27
EZLites	28



DESIGNED BY INSTALLERS, FOR INSTALLERS!

- What the professionals use and easy for the “Do-it-yourself-er” to install.
- Integrated connection system - ideal for **green** roofs - no spikes or clips required.
- Heavy duty construction: will not become brittle to weathering and lasts a lifetime.
- Comes in straight form but can easily be worked with for curved applications
- Ideal for garden beds, landscape beds, brick/stone patios, tree rings, and walkways.
- Made from 100% recycled material and comes with karma! ♻️
- Super permeable to promote proper root growth and drainage which eliminates turf brown out.





"CUT ON THE GO" DESIGN.



ALLOWS EDGING TO BE CUT FOR CURVED APPLICATIONS.



WITHOUT PRE-CUTTING OR HAVING TO LIFT EDGING OFF THE GROUND.



CROSS SPIKE TECHNOLOGY MAKES THE EDGING MORE RESISTANT TO HEAVING UP FROM GROUND FROST.



SPIKES CAN GO ANYWHERE IN BETWEEN THE CUT BRACE AND EDGING WALL WHICH HELPS TO DIMINISH EDGE PULL AWAY WHEN INSTALLING.



SUPER FAST BUILT IN CONNECTION SYSTEM. NO CLIPS NEEDED AND HELPS TO SAVE LABOUR TIME.

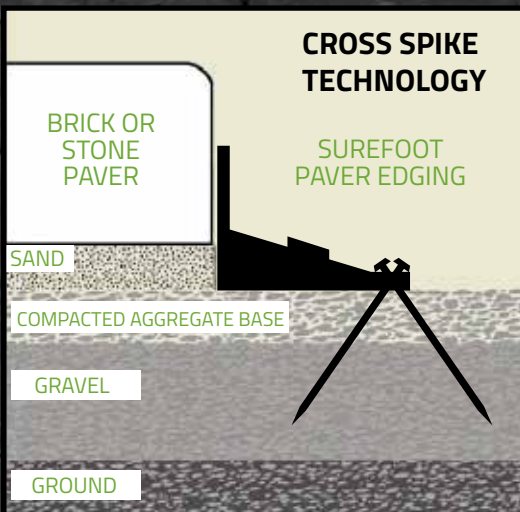

INSTALLATION TIPS:

Driveways:

Nail every 8" (20.3 cm) to 12" (30.5 cm).

For curved areas you can also double spike.

Walkways and Patios:

Nail every 12" (30.5 cm) to 20" (50.8 cm).

For curved areas you can also double spike.

SPECS:

8' length x 1"5/8 height
3" depth x 2.25" width
243.84cm length x 4 cm height
7.68 cm depth x 5.71cm width



VIDEO LINK



VIDEO LINK



**FLEXIBLE
PAVER
EDGING**

**NEW
AND
IMPROVED**

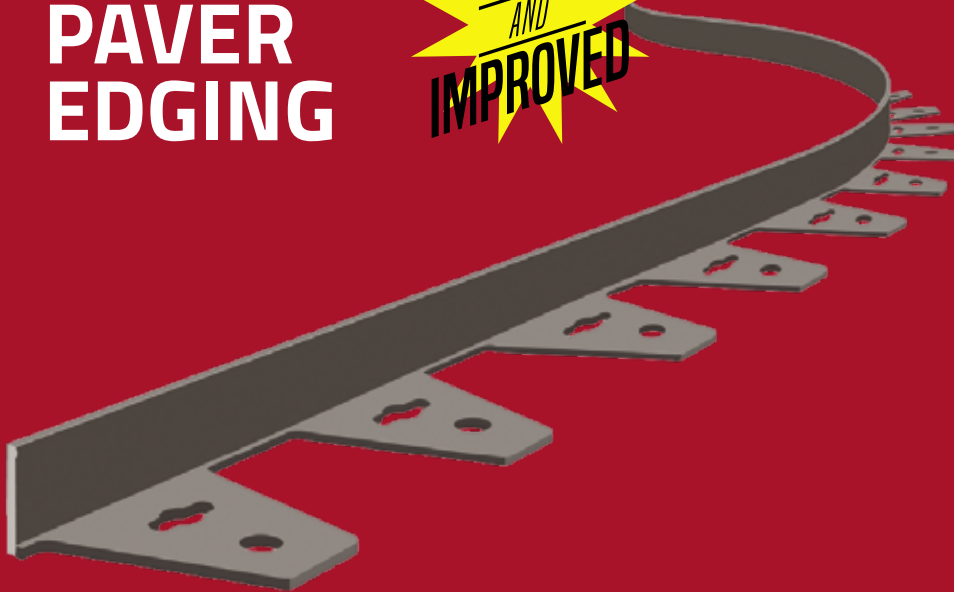

MORE BEEFY, HEAVY DUTY EDGING

- Easy installation.
- Save time - No cutting required for curves.
- Ideal for driveways, patios, and walkways.
- Made from 100% Recycled material and comes with Karma! ♻️



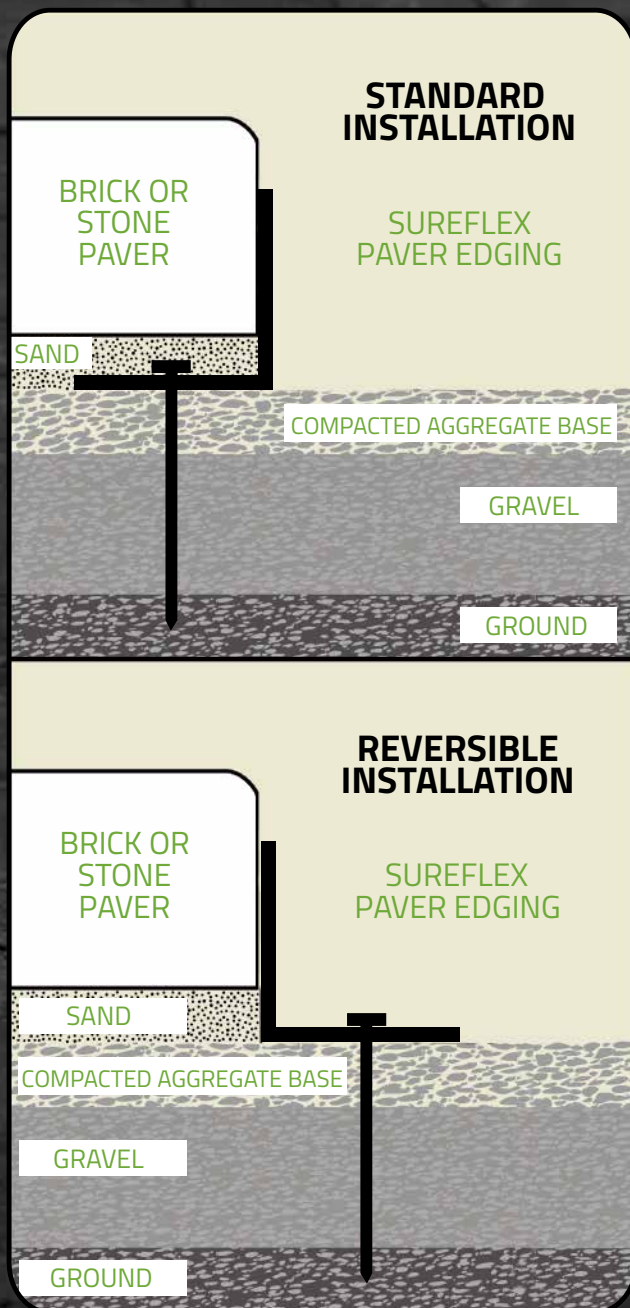

INSTALLATION TIPS:

Driveways:

Nail every 8" (20.3 cm) to 12" (30.5 cm).

Use Standard Installation Only.

Walkways and Patios:

Nail every 16" (40.6 cm) to 20" (50.8 cm) & at either end.

Use Standard or Reversible installation.

SPECS:

Length: 7' 6" (228.60 cm)

Height: 1.75" (4.445 cm)

Thickness: .31" (7.874 mm)



VIDEO LINK



LUMINUM PAVER EDGING

- What the professionals use and easy for the "Do-it-yourself-er" to install.
- Heavy duty construction: will not become brittle to weathering and lasts a lifetime.
- Comes in straight form but can easily be worked with for curved applications/corners.
- Tool-less to do curves, corners or straights.
- Can be installed both standard or reverse installation.
- Low profile so the edge is invisible when properly installed.
- No wasted material due to overlap at joints.
- Comes with plated joiner tabs.
- Made from 100% recycled material and comes with karma! ♻️

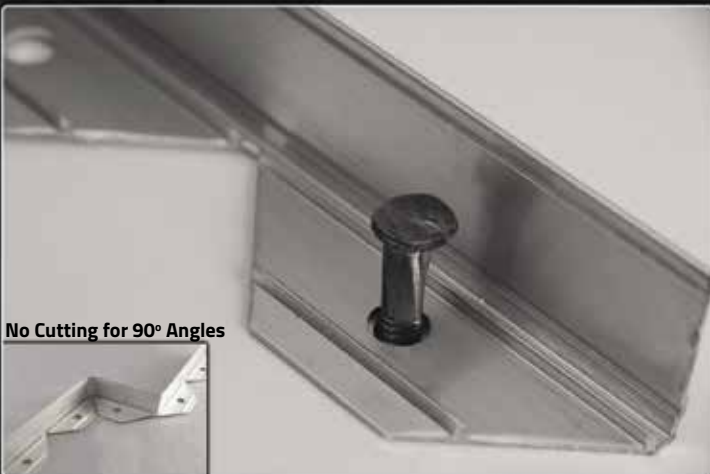

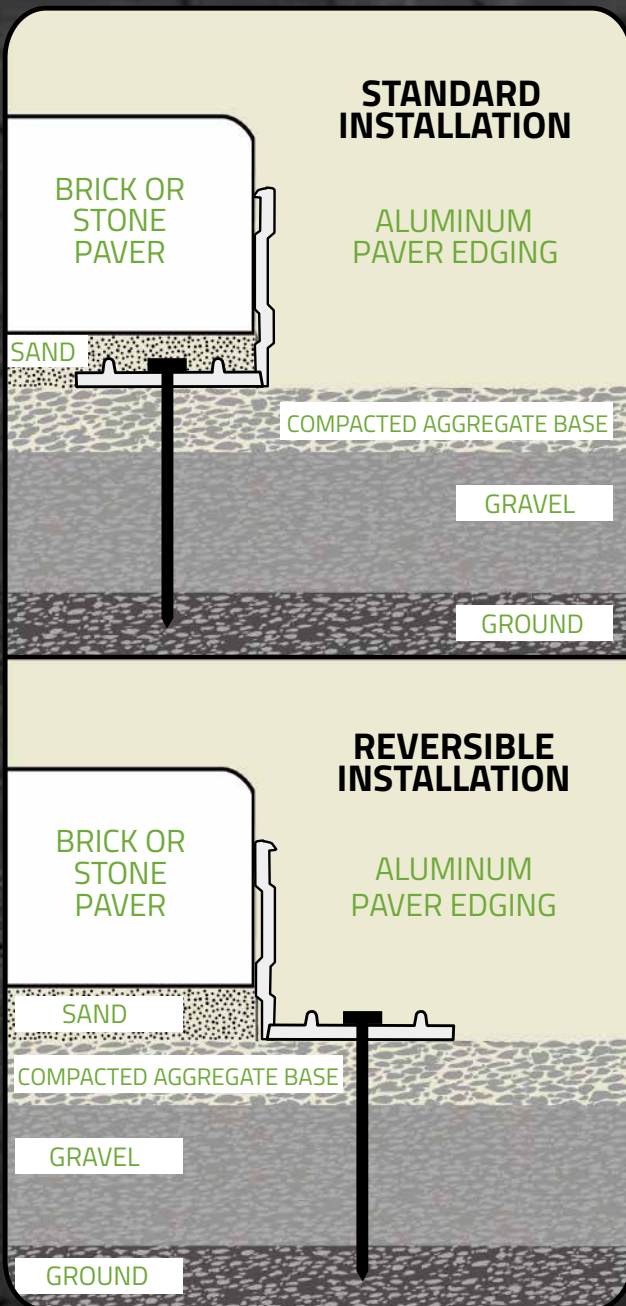

INSTALLATION TIPS:

Driveways:

Nail every 8" (20.3 cm) to 12" (30.5 cm).

Use Standard Installation Only.

Walkways and Patios:

Nail every 16" (40.6 cm) to 20" (50.8 cm) & at either end.

Use Standard or Reversible installation.

SPECS:

Length: 8' 4" (254 cm)

Height: 1.5" (3.81 cm)

Thickness: .125" (3.175 mm)



VIDEO LINK





LOW PROFILE LUMINUM PAVER EDGING

Our Lowest Profile Aluminum Edging is ideal for use with 20mm porcelain pavers, flagstone, wetcast shapes and bluestone. Our aluminum edging bends to your needs no matter how complex your design requirements. Made of aluminum, it's strong enough for straight lines, yet flexible enough to follow the most intricate curved patterns.

- Convenient 8' 4" lengths
- Made of non-rusting Aluminum
- Completely hidden from view
- One piece for straight or curved patterns
- 90 degree angles without cutting
- Will not warp in heat or crack in cold
- No loss of material due to overlap at joints
- Made from 100% recycled material and comes with karma! ♻️

Length: 8' 4" (2.54m)
Height: 5/8" (17mm)
Thickness: 0.125" (3.2mm)
Flange: 1.5" x 4" (35mm x 102mm)
Alloy: 6063 aluminum
T-5 hardness
US Patent



GRATEFUL EDGE

Professional Grade Garden Edge
100% Recycled Material & Comes With Karma! ♻️

PLATINUM EDGE



Durable corrugated side wall construction with T-Shape flange allows for easy and secure installation.

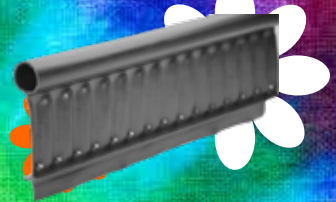

*NOTE - CONNECTORS ARE REQUIRED

PRIMO EDGE



Primo Edge was developed to offer quality and performance at an economical price.

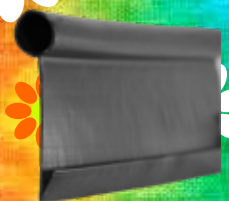

*NOTE - CONNECTORS ARE REQUIRED

SIMPLE EDGE

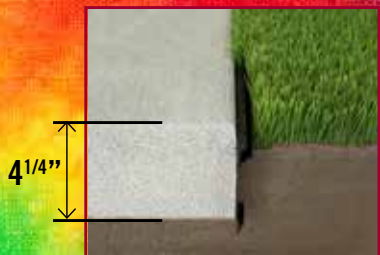

Patented design eliminates the need of a garden edger. It's one time installation inhibits grass from growing onto walkways and concrete driveways, making this product Eco Friendly and a true time saver.



Anchor Stakes

9" x 1"
Galvanized Steel
100 pcs per case



Straight Connector

6"
100 pcs per case



90° Corner Connector

Durable Injection Mold
25 pcs per case



ROCKSTAR

Garden Edge



Rock Star 4" Professional Garden Edge

- Ideal for both commercial and residential use
- EZ-Connect System - saves labour time
- Heavy Duty/Beefy Edge so straight lines are easy
- Flexible to allow for perfect curves

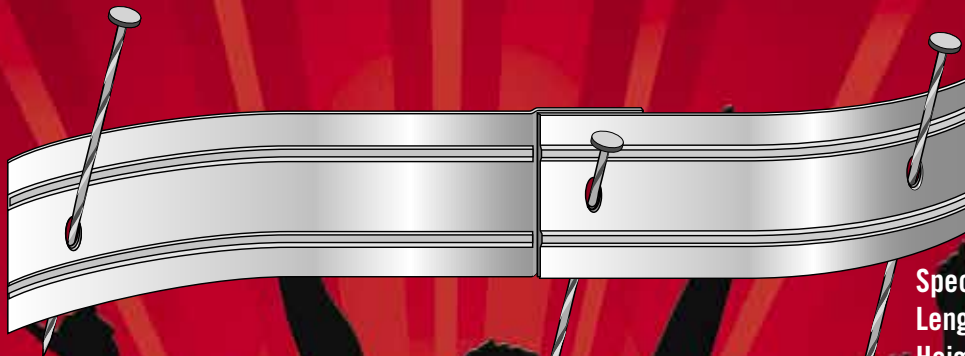
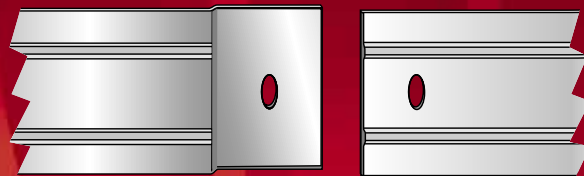

Specs:
Length: 8' (2.43m)
Height: 4" (10.1cm)
Thickness: 1/8" (3.2mm)

Premium Quality

- Forget Plastic "Rolled" Big Box Edges
- 8 ft Lengths - bigger sizes do not stay straight
- For Garden Beds, Tree Rings, Walkways, Patios
- 100% Recycled Material & comes with Karma! ♻️
- Non rusting Aluminum



VIDEO LINK

ROCK STAR

Garden Edge

BACK IN BLACK

Rock Star 4" Professional Garden Edge

- Ideal for both commercial and residential use
- EZ-Connect System - saves labour time
- Heavy Duty/Beefy Edge so straight lines are easy
- Flexible to allow for perfect curves



Specs:
Length: 8' (2.43m)
Height: 4" (10.1cm)
Thickness: 1/8" (3.2mm)

Premium Quality

- Forget Plastic "Rolled" Big Box Edges
- 8 ft Lengths - bigger sizes do not stay straight
- For Garden Beds, Tree Rings, Walkways, Patios
- 100% Recycled Material & comes with Karma! ♻️
- Non rusting Aluminum
- Durable black anodized finish

ROCK/STAR™

Garden Edge

XTRA  STRENGTH

- **Keyhole Interlocking System:** Lengths are easily and quickly connected.
- **Superior Reinforcement – 8 ft lengths:** Rigid enough to provide perfectly straight lines; flexible enough for the most demanding curves.
- **No need to use heavier gauge or more costly material to maintain straight runs.**
- **Heavy duty 1 1/8" nail loops located every 23":** allows for more frequent nailing positions, providing superior anchoring where required.
- **Steel Nail Anchoring:** Spiral 10" nails readily available.
- **100% Recycled Material & comes with Karma!** ♻️

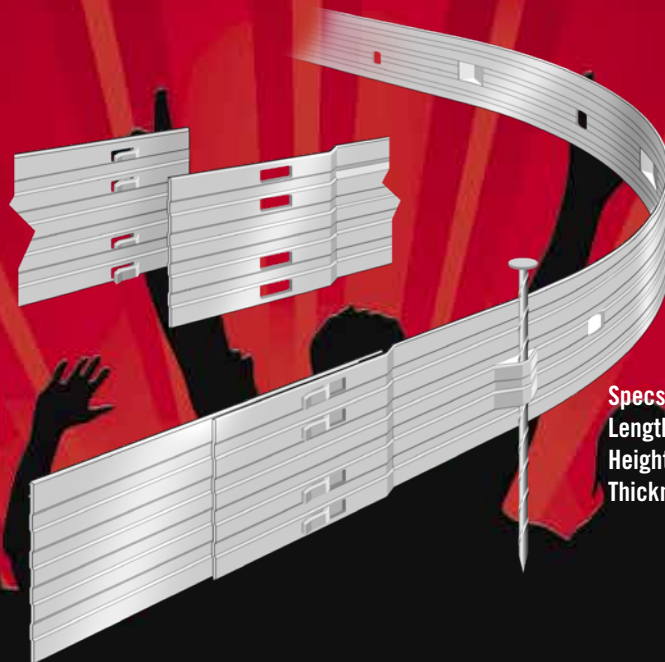

Specs:
Length: 8' (2.43m)
Height: 4" (10.1 cm)
Thickness: 1/8" (3.2mm)

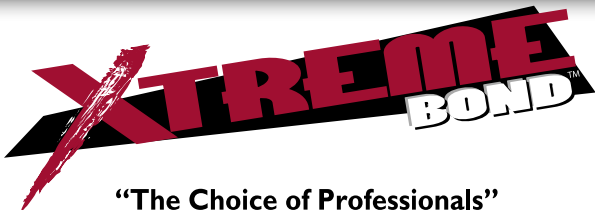

“The Choice of Professionals”

Extra Strength Adhesive Premium Polyurethane



Why compete with the big box stores? We can give you your own exclusive brand.



Works on wet & frozen surfaces!! Don't believe us? Ask for a sample!!

- Quick adhesion and fast drying
- Works on concrete, brick, wood, metal, stone and fibreglass
- Works in all temperatures
- Premium Polyurethane
- VOC compliant
- Ideal for artificial turf
- Guaranteed to satisfy the highest of demands



VIDEO LINK

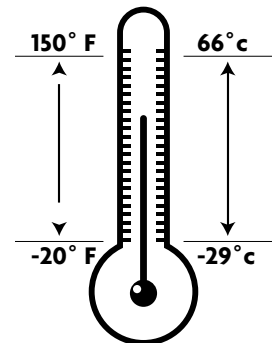

10.5 oz 24 tubes per case
60 cases / 1440 tubes per pallet

29 oz 12 tubes per case
60 cases / 720 tubes per pallet



INVERTED MARKING PAINT



Features:

- Extremely bright
- Inverted tip
- Quick drying - won't clog
- Water based - safe on plants and grass
- Lead free
- 17 oz can / 12 per case

Colors Available:

- Fluorescent Orange ⚡
- Fluorescent Red ⚡
- Hot Pink ⚡
- White ⚡



MPG33 - 33" Marking gun



MPG14 - 14" Marking gun

GEOGRID

RETAINING WALL SYSTEM

- ❑ Retaining Walls, Steep Slopes, Timber Walls, Paver Reinforcement, Landscape repair
- ❑ Recommended For Wall Heights up to 6 ft
- ❑ Biaxial - CMD 882 lbs / ft
- ❑ LTDS - MD 822 lbs / ft
- ❑ 12 Rolls - 4 ft x 50 ft / "Pop Off Top" Display
- ❑ Other Sizes:
 Geo Grid 150 - 6' x 150' Roll - 45 lbs - 100 SQ. YDS
 Geo Grid 200 - 6' x 300' Roll - 110 lbs - 200 SQ. YDS
 Geo Grid 350 - 6' x 300' Roll - 130 lbs - 200 SQ. YDS

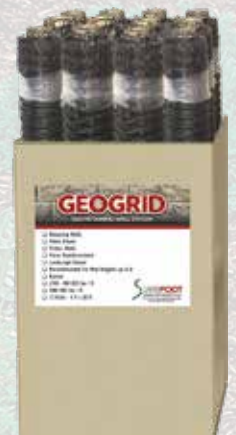





The WEDGIE!!

Had a **WEDGIE** Lately??





- Load bearing up to 8,000 psi
- Weatherproof and will not rot, shrink, warp or split
- Easy break off points, amazing support and easy way to align
- UV treated so it will not become brittle
- Recommended for pavers, retaining wall caps, masonry, concrete and many other uses
- Injection molded sheets of 10 / 36 sheets per case

		HEEL	MID	TOE
EZ-SHIM		8,029 psi	7,993 psi	7,947 psi
CEDAR		1,367 psi	1,711 psi	5,370 psi
PINE		1,848 psi	2,288 psi	4,215 psi

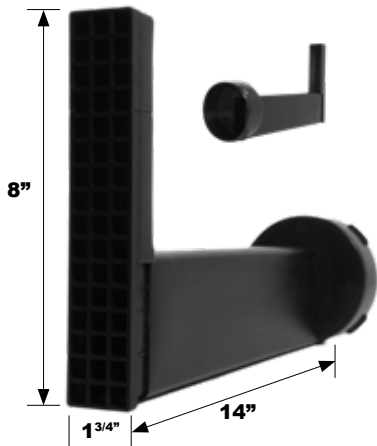

WALL DRAIN PRO

Meet **WALDO!**
THE UNIVERSAL WALL DRAIN



BLACK: SWD-BL
GREY: SWD-GR
BEIGE: SWD-BE

- Designed for all 3" - 8" blocks.
- Easy installation
- Esthetically pleasing
- Reduced labour costs / No more cutting holes
- Height easily modified for use with any size block or timber
- Male end snaps into 4" TEE
- Case pack - 12 pcs
- Available in Black, Grey or Beige



**AVOID
UNSIGHTLY
DRAINS**



GET **HAMMERED** WITH



**MADE
IN
GERMANY**

HALDER

ALL HAMMERS CARRY A LIFETIME WARRANTY!!



3.5 Lbs

Paver Mallet STH-416

Perfect for Large Wall Projects

- 13" Hickory Wood Handle
- Cast Iron Head Casting
- 2^{3/8"} (60mm) Changeable Inserts
- Overall Length - 16"

Inserts included:

STH-416A: Black - Composite Rubber/Medium Hard

STH-416B: Red - Plastic/Hard

STH-416C - Blue (Non-Marring) - Soft



3.2 Lbs

Baseplex Paver Mallet STH-417

The Universal Hammer

- Ash Wood Handle
- Zinc Die Cast Head
- 2" (50mm) Changeable Inserts
- Overall Length - 13.25"

Inserts included:

STH-417A: White - Nylon/Hard

STH-417B: Red - Plastic/Hard



7.4 Lbs

Sledge Mallet STH-418

The Ultimate Sledge Mallet

- 31" Hickory Wood Handle
- 7lb Cast Iron Head Casting
- 3^{1/8"} (80mm) Changeable Inserts
- Overall Length - 31.4"

Inserts included:

STH-418A: Black - Composite Rubber/Medium Hard

STH-418B: White - Superplastic/Medium Hard



6.6 Lbs

Wall Paver Mallet STH-419

Ideal for Retaining Wall Cap/Stones

- 19" Hickory Wood Handle
- Cast Iron Head Casting
- 3^{1/8"} (80mm) Changeable Inserts
- Overall Length - 19.25"

Inserts included:

STH-419A: Black - Composite Rubber/Medium Hard

STH-419B: White - Nylon/Hard



1.6 Lbs



5.5 Lbs

Dead Blow 40mm: STH-420 70mm: STH-421

The Only Dead Blow to use

- Hickory Wood Handle
- Two white nylon changeable inserts
- Overall Length - 4" (40mm) 4.5" (70mm)

Inserts included:

STH-420A: White - Nylon/Hard

STH-421A: White - Nylon/Hard



GET **HAMMERED** WITH



ALL HAMMERS CARRY A LIFETIME WARRANTY!!



Problem Solver Brick Hammer STH-429

- 11" Total Length
- 1" Face Diameter
- Quality Forged Steel
- Anti-Vibration Grip
- Unique "Toothed" Brick Hammer Design
- **1.32 Lbs Total Weight**



Black Giant Brick Hammer STH-430

- 11" Total Length
- Quality Forged Steel
- Anti-Vibration Grip
- **1.32 Lbs Total Weight**



Stone Sledge STH-431

- 10.6" Total Length
- Black Powdered Coated, Corrosion-Resistant Head
- Made from special hardened and tempered PICARD steel
- Slightly Curved Face
- Dual Curved Ash Handle
- **2.75 Lbs Total Weight**



Long Handle Stone Sledge STH-432

- 31.4" Total Length
- Black Powdered Coated, Corrosion-Resistant Head
- Made from special hardened and tempered PICARD steel
- Ash Handle
- Slightly Curved Face
- **11 Lbs Total Weight**



Tumbler Hammer STH-433

- 14" Total Length
- Black Powdered Coated, Corrosion-Resistant Head
- Made from special hardened and tempered PICARD steel
- Both Faces with Teeth
- Dual Curved Ash Handle
- **2.2 Lbs Total Weight**



SUREFOOT

HARDSCAPE PRODUCTS INC.

ACCESSORIES AND TOOLS



STH-411 Deluxe Paver Persuader
Galvanized steel handle / Angled rubber head
Weight - 8 lbs
36" Handle
7 Year Warranty - Except Pads



STH-412 Double Headed Paver Mallet
Galvanized steel handle / Flat rubber head
Weight - 5.5 lbs
15" Handle
7 Year Warranty - Except Pads

STH-414 Dead Blow
4 lbs.
Case of 12



STH-415 Rubber Mallet
32 oz.
Case of 24



High-Modulus Polyethylene Thermoplastic

- Attaches to many different plate compactors with its universal size of 19" wide x 24" long x 0.25" thick. Flexible front lip.
- Mat includes 1 pair universal aluminum mounting brackets.
- Allows for a quick attachment at any point during a project without slowing down the job.
- Keeps the travel speed and compaction force you need when making that critical final pass over the pavers and poly sand.
- Lasts for a long time because it has a high abrasion resistance and low coefficient of friction.
- May be cut down to small sizes.

Aluminum SSR-210 Screed Rail



Lightweight 1" x 8"
0.25" Diameter

Aluminum SSR-211 Screed Bar



Super Light
Hollow 1" x 4" 4'
6'
8'

Chisels

Ideal for Brick - Case of 12

- SCL-211** 3"
- SCL-212** 4"



SCL-213

- 3.14" Width
- Black Powder Coated, Corrosion-Resistant
- Tapered
- For stone working, beating silts or patterns in soft stone
- Also suitable for Natural Stone
- 1.8 Lbs

SCL-214

- 3.94" Width
- Black Powder Coated, Corrosion-Resistant
- Tapered
- For stone working, beating silts or patterns in soft stone
- Also suitable for Natural Stone
- 2.4 Lbs



SPB-311

Paver Extractor
Adjustable 7.8" - 11.8"

- Galvanized - won't rust
- 7 year warranty - except blades

SPB-312

Paver Aligning Bar

SPB-313

Paver Lifter Small
from 0"-21"

SPB-314

Heavy Duty Paver Lifter
from 16"-27"

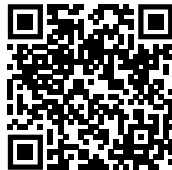

VIDEO LINK

STG-241 Economy Knit

Rubber/Latex Coated Palm
Available by the Dozen.

XL Only
Case of 30



Caulking Guns

Heavy Duty Construction

- STC-221** 9" Case Pack 24
- STC-222** 13" Case Pack 12



Stiff Bristle / Exterior Broom

- SLB-18** 18"
- SLB-24** 24"



Landscaping / Grading Rake

- SLR-30** 30"
- SLR-36** 36"
- SLR-42** 42"
- SLR-48** 48"

- All aluminum construction
- Won't rust



ADJUSTABLE (FINISHING) ALUMINUM SAND SCREED

- From 3' - 5'
- Built in bubble level
- Removable handle for transport
- All aluminum construction
- Won't rust





SUREFOOT

HARDSCAPE PRODUCTS INC.

LIFTING EQUIPMENT



Paver Cart

FEATURES:

- Large pneumatic turf-profile tires • solid steel pallet roller
- Handle assembly detaches for easy transport
- Reinforced cross-braced handles prevent twisting
- Foot bar for increased leverage
- Can be used for both palletized/unpalletized materials
- Shipping weight: 165 lbs. • Overall dimensions: 40" x 21" x 69"
- Safe Lifting Load: 600 • Width adjusts from 34"-40"



Jed Clamp It/ Tread/Curb Clamp

J900	4"-22" max width	900 lbs max weight
J2400	8"-32" max width	2400 lbs max weight
J3000	12"-42" max width	3000 lbs max weight

Tread Setter



	Capacity	Rise	Depth
T600	600 lbs	6"-8"	12"-25"
T1200	1200 lbs	6"-8"	20"-35"

Montolit Curb Clamp

Mechanical or hand-lifter.
3.15"-7" 440lb capacity



STH-424 Curb Lifter

Range 1/2" - 10"
Weight - 10 lbs



STH-425 Two Man Curb Lifter

Range 19.5" - 43"
Weight - 25 lbs
Max Weight - 330 lbs
Detachable for Skid Steer/Bobcat
Galvanized - won't rust
7 year Warranty - Except Pads



VIDEO LINK



STH-426 Two Man Curb Stone Lifter

Range - 1/2" - 11.5"
Weight - 26 lbs
Depth - 8.25
Max Weight 440 lbs
Galvanized - won't rust
7 Year Warranty - Except Pads



VIDEO LINK

STH-428 "Smart Grip" Lifting Clamp

Ideal for handling stone with flat surfaces
Attachable to loading crane, mini-excavator/skid steer to allow one person to guide for precise placement.
Two handles also allowing for a two-man manual operation.
Range - 1/2" - 16.5"
Weight - 28 lbs
Depth - 5.5
Max Weight 1200 lbs
7 Year Warranty - Except Pads



VIDEO LINK



GRABO Pro 2.0



Kit Includes:

GRABO Pro-Lifter comes as a complete unit, with pre-installed battery and vacuum seal.



That is not all. There are other accessories in the kit, including a multi-socket charger and a heavy duty carry bag. The complete kit is packaged in a functionally design colourful box.



Package Contents:

- | GRABO Pro Tool (2021 Model with digital display)
- | Multi-socket charger
- | Battery (preinstalled on the tool)
- | Seal (preinstalled on the tool)
- | Tough Oxford fabric carry bag
- | Operator's manual in English

GRABO Pro 2.0 Weight lifting safety parameters

Material / Direction	Glass	Ceramic tiles	Metal	Plastic	wood	Rough Slate	Rough Concrete	Dry Wall
 PERPENDICULAR HOLD	375 Lbs (170 kg)	375 Lbs (170 kg)	242 Lbs (110 kg)	220 Lbs (100 kg)	220 Lbs (100 kg)	176 Lbs (80 kg)	176 Lbs (80 kg)	165 Lbs (75 kg)
 PARALLEL HOLD	265 Lbs (120 kg)	265 Lbs (120 kg)	242 Lbs (110 kg)	220 Lbs (100 kg)	143 Lbs (65 kg)	176 Lbs (80 kg)	176 Lbs (80 kg)	143 Lbs (65 kg)

GRABO ACCESSORIES



ERGUSI Attachment

Ergonomically designed attachment allows the worker to operate the GRABO tool without bending.



High-capacity battery

A full battery charge delivers up to 900 operating cycles or 1.5 hours of uninterrupted run time. Can be used with all models except GRABO H.



Extra Seals

Replacements for worn seals with diminished lifting capacity. Patented high friction foam-rubber seal fits all GRABO models.



RockSeal™

New seal system that fits all GRABO models, including Nemo GRABO, GRABO Pro-lifter 2.0, RTC tools Grabo, FXAH-120 Probst GRABO, Topspin Powertools GRABO and other co-branded units.

This patented seal is designed specifically for extremely rough stone and rock surfaces with up to 10mm surface profile.

SPLITTERS



BK43 Paver Splitter STH-422
Range - 0" - 4" Blade Length - 13" Weight - 62 lbs

6L Paver Cutter STH-423
Range - 0" - 3.9" Blade Length - 12" Weight - 66 lbs

SF 3300
Fixed hardened galvanized knife, 4 edges
Range - 1/2" - 6"
Blade Length - 13"
Weight - 80 lbs
2 spindles to adjust height
Holding plate
Spring Loaded Cut
7 Year Warranty



VIDEO LINK

SF 4300
Fixed hardened galvanized knife, 4 edges
Range - 1/2" - 6"
Blade Length - 17"
Weight - 125 lbs
2 spindles to adjust height
Holding plate
Spring Loaded Cut
7 Year Warranty



VIDEO LINK



SF 4300 EX - EXTRA HEIGHT

Ideal for slab stones and blocks of rocks
Fixed hardened galvanized knife, 4 edges
Range - 1/2" - 11.8"
Blade Length - 17"
Weight - 145 lbs
2 spindles to adjust height
Holding Plate
Spring Loaded Cut
7 Year Warranty



VIDEO LINK



Tom Thumb Mini Brick Cutter STH-427

Range - 0" - 4.5"
Blade Length - 4.5"
Weight - 6 lbs
7 Year Warranty



VIDEO LINK



Fairport Block & Paver Splitter FBS 40

- Designed for splitting:
- Retaining Wall
 - Cap Stone
 - Rough Cut Face Stone
 - Paving Stones
 - Granite and most other flat stone materials on the market today



VIDEO LINK



Spring loaded tray for angled "undercuts" when cutting pavers.

Easy one dial system:
For perfect cuts every time (No need to set screw every time when cutting same size stone)

Great cutting range:
Cutting width: 16"
Cutting height: 8.3"
Weight: 135 lbs

Fairport Hydraulic Block & Brick Splitter FBS 60

Designed for splitting:

- Retaining walls
- Cap stone
- Rough cut face stone
- Granite
- Paving stones - and most other flat stone materials on the market today
- Over 20 ton cutting force
- Spring loadfedd tray for angled “undercuts” when cutting pavers
- Adjustable blade height for all “flat faced” products up to 235 mm

- Cutting width; 25.6”
- Cutting height: 9.25”
- Length: 28.74”
- Width: 32.38”
- Height: 40.95”
- Weight: 218.26 lbs



VIDEO LINK



LITE ON RETAINING WALL LIGHT



FEATURES

- 20,000 Hour Lifespan
- Energy Efficient - 1.9 Power Watt That Emits “Warm” Light
- 30 SMD High Output LED’s Per Fixture
- 5 Year Warranty (When Used With Approved DC Transformer)
- Waterproof Design - 1P66 Rating*
- UV Treated Polycarbonate Lens - Will Not Brown Or Yellow
- Quick And Easy Installation - Comes With 6ft Lead Wire
- 30 Year Warranty On Corrosion Resistant Powder Coated Finish
- Heavy Duty Die Cast Aluminum Body

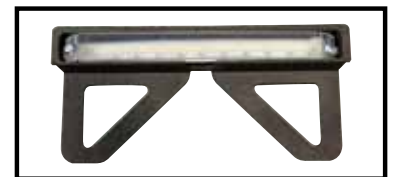

BOTTOM



FRONT

DIMENSIONS

7 1/4” Wide x 3/4” Tall x 1” Deep

Available Colors:



•Bronze Sparkle



•Matte Black



•Classic Brown



PAVER SPOT



PAVER SPOT

- Waterproof and submersible
 - Energy efficient and emits a “warm” light with a durable polycarbonate shell
 - Suitable for driveways, walkways, steps, decks, docks and more
 - 10 year warranty, 100,000 hour rated
 - 1.5 Watts, 1” Diameter, Height 5/8”, 6’ lead wire
- Available in 4 spot packs or complete kit (contains 8 spots, 60 Watt Transformer, Timer, Gel Caps)

DC TRANSFORMERS

- 36, 60, 100 watt versions
- DC specific constant even power supply
- 3 year warranty
- Waterproof (IP66) suitable for indoor or outdoor use
- Over voltage and thermal protection
- UL and ETL Safety rated

AC TRANSFORMERS

- 60 and 100 watt versions
- 5 year warranty
- Waterproof (IP66) suitable for indoor or outdoor use
- Over voltage and thermal protection
- UL and ETL Safety rated
- Built in photocell / timer

PHOTOCELL TIMER

- Indoor or Outdoor use
- Multiple time on/off settings
- 1 yr warranty
- Photo activated for hassle free on/off

LOW VOLTAGE WIRE

- Outdoor Rated, UL approved
- 16 Gauge Wire - 100’ rolls - Suitable for runs over 75’

OUTDOOR GEL WIRE NUTS

- UL approved
- 10 per pack





SUREFOOT

HARDSCAPE PRODUCTS INC.

SLIM SHADY

RETAINING WALL LIGHT



- 6 led x 20 lm per led = 120 lumen
- Wattage 2 Watts
- Warm White: 2725 ± 70 °K
- Wire length: 1.5 m (4' 11")
- cETL
- 12V AC/DC
- Fully assembled units available in Black and Grey
- Dimensions - 6^{7/8}" wide x 3/4" tall x 1" deep



CYCLOPS

PAVER LIGHT



- Voltage 12V AC/DC
- Wattage 0.4W
- # of LEDs 6
- Beam degree 90°
- Frosted Lens
- Brushed Nickel metal trim
- Color Temperature : 2725 ± 70 °K
- Dimensions 1.25 x H.73in (30.5x H18.5mm)
- Lumens 25
- IP Rating 66 - Indoor/Outdoor
- Certification cETLus





High Power, Adjustable Accent Light

- Includes: 17W, 1100 lumens, 3000K
- Power can be dialed down to 3W, 250 lumens
- 20° to 60° adjustable beamspread
- Humidity evacuation system
- IP65
- Includes a 12" aluminum spike
- Louver included
- Rugged brass construction
- Bulb Included
- 5 year warranty

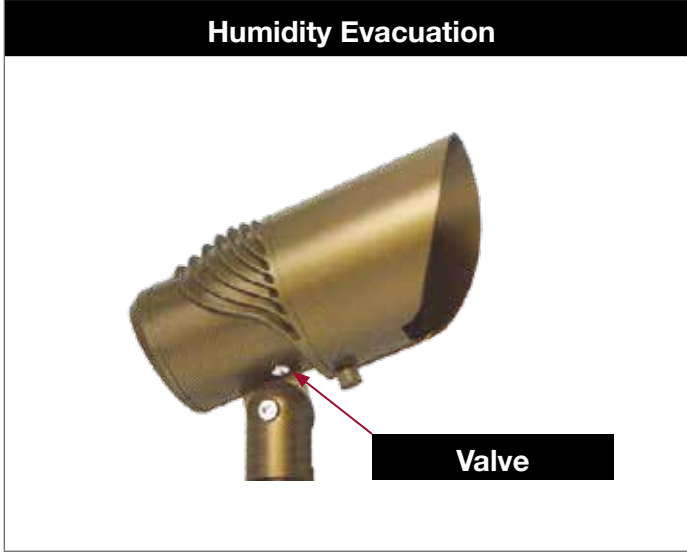

MR16



- Sturdy brass MR16 accent light
- Angled glare shield length adjustable from 130 mm to 155 mm
- No tools required to relamp, aim the luminaire or adjust the glare shield.
- Stake included
- **Lamp not included. See page 28 for a selection of MR16.**
- **5 year warranty**

MR08



- Sturdy brass MR08 accent light
- Angled glare shield length adjustable from 80 mm to 110 mm
- No tools required to relamp, aim the luminaire or adjust the glare shield.
- Stake included
- **Lamp not included. See page 28 for a selection of MR08.**
- **5 year warranty**

Bi-pin Flood

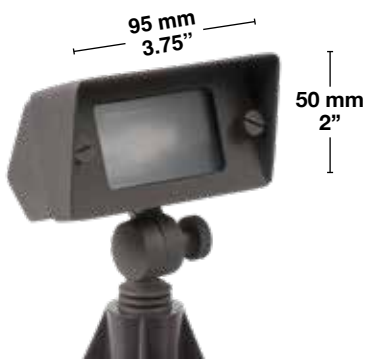

- Sturdy brass mini flood
- 2.5W, 3000°K, **LED bi-pin already installed in the fixture**
- G4 socket
- Stake Included
- Bulb Included
- **5 year warranty**

EZL103AB

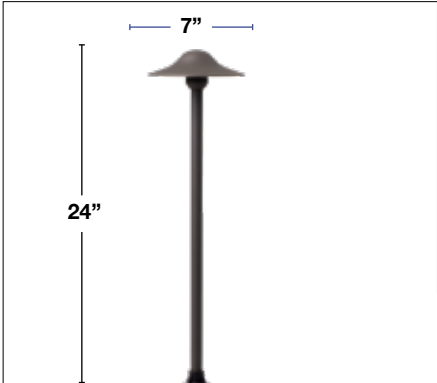

- Sturdy brass construction
- 2.5W, 3000°K, **LED bi-pin already installed in the fixture**
- Stake included
- **5 year warranty**



BBK

EZL106AB

EZL106BBK

EZL102AB

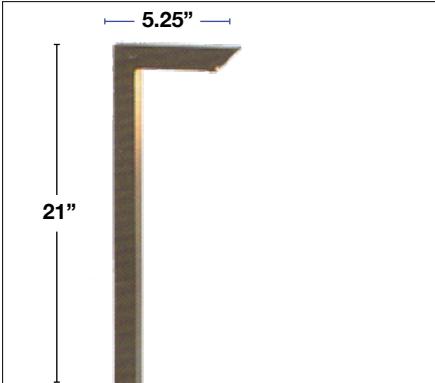

- Sturdy brass construction
- 2.5W, 3000°K, **LED bi-pin already installed in the fixture**
- Stake included
- **5 year warranty**



BBK

EZL105AB

EZL105BBK

EZL104AB



BBK

EZL105AB

EZL105BBK



BK

- MR16 aluminum accent light
- Angled Glare Shield
- Stake Included
- **Lamp not included. See page 28 for a selection of MR16.**
- **5 year warranty**

EZL101BZ

EZL101BK



EZL901AB - 2" Riser

EZL902AB - 7" Riser

EZL903AB - 12" Riser

EZL904AB - 18" Riser

• **5 year warranty**

12" Spike



Aluminum Mounting Bracket



EZL905BZ

• **5 year warranty**



75W Model

Transformer : 75W

- 75W Transformer
- Sturdy stainless steel built
- Output taps: 12 and 15 Volts
- Built-in mechanical timer and photocell plug
- Epoxy encapsulated toroid coils for higher efficiency and lower heat generation
- Thermal protection with auto-reset on the primary side
- Secondary side magnetic circuit breaker
- Drop down bottom
- **10 year warranty**



150W Model

Transformer : 150W, 300W & 600W

- Sturdy stainless steel built
- Output taps: 12, 13, 14 and 15 Volts
- Timer and photocell plugs
- Room for most commonly used timers
- Removable, lockable hinged door
- Large, robust terminal block
- Drop down bottom
- Epoxy encapsulated toroid coils for higher efficiency and lower heat generation
- Thermal protection with auto-reset on the primary side and secondary side magnetic circuit breaker
- Multiple knockouts
- **10 year warranty**

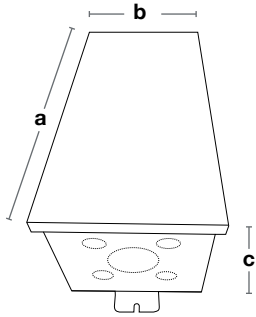

Part #	Watts	Dimensions (mm)			Taps
		a	b	c	
EZLT7a5	75	170	110	115	12 & 15
EZLT150	150	295	153	140	12, 13, 14 & 15
EZLT300	300	325	155	140	12, 13, 14 & 15
EZLT600	600	365	170	170	12, 13, 14 & 15

Lamp	Base	Volts	Product #	Watts	Beamspread	Color	Lumens	CRI	Avg. Life	MOL
------	------	-------	-----------	-------	------------	-------	--------	-----	-----------	-----

MR16	GU5.3	12	EZL219	4	30°	3000°K	310	80+	25 000	50 mm
			EZL220	4	45°	3000°K	310	80+	25 000	50 mm
			EZL221	4	60°	3000°K	310	80+	25 000	50 mm



FC • 5 year warranty

Lamp	Base	Volts	Product #	Watts	Beamspread	Color	Lumens	CRI	Avg. Life	MOL
------	------	-------	-----------	-------	------------	-------	--------	-----	-----------	-----

MR16	GU5.3	12	EZL240	7	45°	3000°K	475	80+	25 000	50 mm
------	-------	----	--------	---	-----	--------	-----	-----	--------	-------



FC • 5 year warranty

Lamp	Base	Volts	Product #	Watts	Beamspread	Color	Lumens	CRI	Avg. Life	MOL
------	------	-------	-----------	-------	------------	-------	--------	-----	-----------	-----

MR08	GU4	12	EZL201	2.5	30°	3000°K	160	80+	25 000	36 mm
			EZL202	2.5	80°	3000°K	160	80+	25 000	36 mm



FC • 5 year warranty

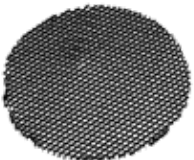

Louver				
Part #	Source	Cell Dia	Depth	Cut-Off
EZR16	MR16	¼"	.235"	45°

Lamp	Base	Volts	Product #	Watts	Beamspread	Color	Lumens	CRI	Avg. Life	MOL
------	------	-------	-----------	-------	------------	-------	--------	-----	-----------	-----

T3	GU4	12	EZL301	2.5	360°	3000°K	250	80+	25 000	32 mm
----	-----	----	--------	-----	------	--------	-----	-----	--------	-------



FC • 5 year warranty

WE WILL
ROCK YOU!



VIDEO LINK



SUREFOOT

HARDSCAPE PRODUCTS INC.

1.877.442.4457 WWW.SUREFOOTEDGING.COM

INFO@SUREFOOTEDGING.COM

Follow us on:



YouTube